

MX LINE



cmatic[®]
PNEUMATIC FITTINGS

Raccordi Automatici in Acciaio Inox 316L
316L Stainless Steel Push-in Fittings
Raccords Instantanés en Acier Inox 316L
Steckverschraubungen aus Edelstahl 1.4404



I Raccordi Automatici della serie MX, realizzati completamente in Acciaio Inox 316L (1.4404), permettono di realizzare connessioni in ambienti e condizioni di impiego dove l'usuale raccorderia in ottone risulterebbe incompatibile all'uso.



The push-in fittings of the MX line are entirely made of AISI 316L (1.4404) and allow for connections in environments and applications, where any standard fitting would be incompatible for use.



Les raccords de la série MX sont entièrement en AISI 316L (1.4404) et ils permettent la connexion dans des endroits et des conditions, où les raccords habituels seraient incompatibles à l'emploi.



Die Steckverschraubungen der MX Baureihe sind aus Edelstahl 316L (1.4404) und ermöglichen die Verbindungen in Umgebungen und unter Zuständen, bei denen die üblichen Messingverschraubungen nicht geeignet sind.

MX

1 - 2	3	4	5	6
Corpo ed anello estrattore Body and Release Ring Corps et poussoir Körper und Lösering	Pinza aggraffaggio Gripping ring Pince Spannzang	Anello di Ritegno Holding Ring Bague de retenue Haltering	Anello porta pinza Protection Ring Bague protection Schutzring	Guarnizioni Seals Joint d'étanchéité Dichtung
Acciaio Inox AISI 316L (1.4404) Stainless Steel AISI 316L (1.4404) Acier Inox AISI 316L (1.4404) Edelstahl AISI 316L (1.4404)	Acciaio INOX AISI 301 Stainless steel AISI 301 Acier Inox AISI 301 Edelstahl AISI 301	Acciaio Inox AISI 316L (1.4404) Stainless Steel AISI 316L (1.4404) Acier Inox AISI 316L (1.4404) Edelstahl AISI 316L (1.4404)	Acciaio Inox AISI 316L (1.4404) Stainless Steel AISI 316L (1.4404) Acier Inox AISI 316L (1.4404) Edelstahl AISI 316L (1.4404)	FPM conforme FDA FPM Compliant With FPM conforme à FDA FPM, FDA Konform

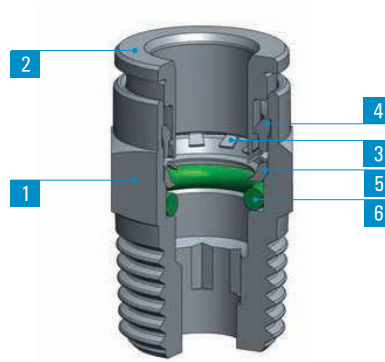

	M5x0,8	G1/8	G1/4	G3/8	G1/2	R1/8	R1/4	R3/8	R1/2
4	●	●	●			●	●		
6	●	●	●			●	●		
8		●	●	●		●	●	●	
10			●	●	●		●	●	●
12			●	●	●		●	●	●

SPECIFICHE TECNICHE

Tubi di collegamento consigliati:
Tubo in PVDF, Tubo in PTFE, Tubo in Acciaio Inox (per l'impiego di tubo in metallo si rimanda alle Istruzioni di Montaggio)
Tolleranze accettabili sui tubi:
+/- 0.07 mm fino a Ø 10 mm
+/- 0.1 mm da Ø 10 a Ø 12 mm.

Campi di applicazione:
Pneumatica, Industria Alimentare, Chimica e Medicale-Farmaceutica.

DATA SHEET

Recommended tubings:
PVDF, PTFE and Stainless steel tubes (for metal hose assembly see the instructions above).
Acceptable Tolerances on the tubings:
+/- 0.07 mm up to 10 mm.
+/- 0.1 mm from diam 10 up to 12 mm.

Application fields:
Pneumatics, Food Industry, Chemical, Medical and Pharmaceutical Industry.

REINSEIGNEMENTS TECHNIQUES

Tubes conseillés:
PVDF, Tube PTFE et Tube en acier.
(Pour l'emploi avec tubes en métal, voir les instructions d'emploi).
Tolerances sur les tubes:
+/- 0.07 mm jusqu'au diamètre 10 mm.
+/- 0.1 mm de 10 mm jusqu'à 12 mm.

Domaines d'application:
Pneumatique, Industrie alimentaire, Chimique, Médicale et Pharmaceutique.

TECHNISCHE AUSKÜNFTE

Empfohlene Schläuche:
PVDF, PTFE-Schlauch und Edelstahlrohr (Bei Montage mit Metallrohren siehe die entsprechenden Montageanweisungen).
Schlauchtoleranzen:
+/- 0.07 mm bis Durchmesser 10 mm.
+/- 0.1 mm von 10 mm bis 12 mm.

Anwendungsbereiche:
Pneumatik, Nahrungsmittelindustrie, chemische, medikale und pharmazeutische Industrie.

Profondità di inserimento del tubo

Tubing insertion depth

Profondeur d'insertion du tube

Schlaucheinstecktiefe

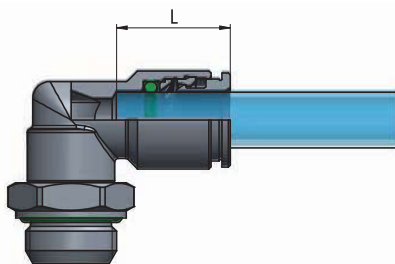

Øe Tube	L
4	13,2
6	16,1
8	16,2
10	18,3
12	19,5

ISTRUZIONI DI MONTAGGIO

ASSEMBLY INSTRUCTIONS

INSTRUCTIONS DE MONTAGE

MONTAGEANWEISUNGEN

1. Tagliare il tubo a 90° (servendosi della pinza tagliatubo TCUT) verificando l'assenza di bave interne ed esterne e facendo attenzione che il tubo non si presenti ovalizzato dopo il taglio. In caso di utilizzo di tubo metallico praticare una scanalatura sul tubo mediante apposito apparecchio (TINC). L'esecuzione della scanalatura sul tubo deve essere in funzione del diametro del tubo in modo da permettere il corretto aggraffaggio della pinza di tenuta del raccordo.
2. Inserire il tubo nel raccordo spingendolo fino in battuta.

1. Cut the tube square (by means of a hose cutter i.e., our TCUT) making sure that no burrs are left and that the tube is not oval.
- In case of use with metal hoses, make a groove all around the tube diameter with a suitable tool (TINC). The groove must be made according to the tube diameter so that the fitting collect can better grip onto it.
2. Insert the tube into the fitting until it bottoms.

1. Sectionner le tube à 90° par notre coupe tube TCUT en prenant soin de ne pas créer des bavures et de ne pas ovaliser le tube. Pour l'emploi avec des tubes en métal, pratiquer une rainure le long du diamètre du tube par un outil adéquat pour l'usage (TINC). La rainure devra toujours être en fonction du diamètre du tube, pour que la pince puisse bien l'agrafer.
2. Pousser le tube jusqu' au fond du raccord.

1. Schlauch mittels unserer Schlauchschere (TCUT) 90° abschneiden und entgraten. Bei Montage mit Metallrohren, eine Nut um den Rohrdurchmesser herum mit dem dazu geeigneten Werkzeug machen (TINC). Die Nut muss im Verhältnis zu dem Rohrdurchmesser stehen, damit die Spannange gut daran klammern kann.
2. Darauf achten, daß der Schlauch danach nicht oval gequetscht ist und dann ihn zum Verschraubungsanschlag einstecken.

Estrazione del tubo

Esercitare una leggera pressione sull'anello estrattore, estraendo contemporaneamente il tubo dal corpo del raccordo.

Tube release

While pressing on the release ring, pull out the tube from the fitting.

Débranchement du tube

Appuyer sur le poussoir en métal et tirer simultanément sur le tube.

Schlauchlösen

Auf den Druckring drücken und gleichzeitig den Schlauch rausziehen.

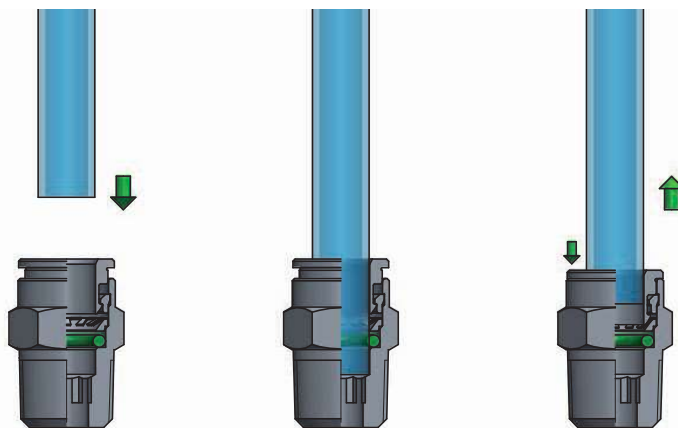

Effettuato il collegamento, assicurarsi che il tubo inserito nel raccordo non sia sottoposto ad alcuna forza di trazione; è necessario inoltre rispettare durante il collegamento del tubo il raggio minimo di curvatura consigliato così come riportato nella sezione tubi di questo catalogo tecnico (vedi pag. 363). Al fine di evitare lo sgancio involontario del tubo nessun oggetto deve venire a contatto con l'anello estrattore del raccordo evitando così l'esercizio di qualsiasi forza indesiderata, anche solo laterale, che potrebbe causare la pressione dell'anello estrattore e conseguente rilascio del tubo. Per il serraggio delle parti filettate del raccordo si raccomanda di attenersi alle coppie consigliate riportate a pag.6



Once the tubing is connected to the fitting, make sure that the tubing is not subject to any tensile strength and that the min. recommended bending radius is complied with (see page 363). To prevent any accidental tube release, no components have to come in touch with the release ring and exercise any unwanted pressure on the same. Indeed however lateral, any load on the release ring may cause the tube disconnection. To tighten threads, please check out our tightening torque chart illustrated at page 6.



Une fois effectué le branchement, s'assurer que le tube inséré dans le raccord n'est soumis à aucune force de traction. Egalement, il est nécessaire de respecter, lors du branchement du tube, le rayon minimum de courbure conseillé dans la section tubes de ce catalogue technique (voir la page 363). Afin d'éviter le décrochage involontaire du tube, aucun objet ne doit entrer en contact avec la bague d'extraction du raccord, empêchant ainsi l'exercice de toute force indésirable, ne serait-ce que latérale, qui pourrait provoquer la pression de la bague d'extraction et donc le relâchement du tube. Pour le serrage des parties filettées du raccord, il est recommandé de s'en tenir aux couples de serrage conseillés et reportés à la page 6.



Nach der Schlauchverbindung, sicherstellen, dass der in die Verschraubung eingeführte Schlauch keinen Zugbelastungen ausgesetzt ist; beim Anschluss des Schlauchs muss der empfohlene Mindestbiegeradius eingehalten werden, gemäß den in diesem technischen Katalog im Schlauchabschnitt, angegebenen Hinweisen (siehe Seite 363). Um das versehentliche Lösen des Schlauchs zu verhindern, darf kein Gegenstand den Lösering der Verschraubung berühren. Keine unerwünschte Kraft darf auch nicht seitlich einwirken und kein Druck soll auf den Lösering ausgeübt werden, denn dies das Schlauchlösen verursachen könnte. Zum Festziehen der Gewinde sich an den, auf Seite 6, empfohlenen Drehmomente einhalten.

MX 11

Diritto maschio conico

Taper straight, male

Union simple mâle conique

Gerade Einschraubverschraubung, kegelig

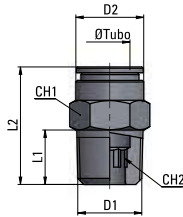

Type	Ø Tubo	D1	D2	L1	L2	CH1	CH2	g ΔΔ
11 04 18	4	R1/8	9	7,5	16,5	10	3	6,3
11 04 14	4	R1/4	9	11	20,5	14	3	16,1
11 06 18	6	R1/8	11,7	7,5	21	12	4	9,5
11 06 14	6	R1/4	12	11	20,5	14	4	14,3
11 08 18	8	R1/8	13,7	7,5	25	14	6	13,5
11 08 14	8	R1/4	13,7	11	23,5	14	6	14,4
new 11 08 38	8	R3/8	13,9	11,5	22,5	17	6	23,7
11 10 14	10	R1/4	15,7	11	30,5	16	8	20,3
new 11 10 38	10	R3/8	16	11,5	24	17	8	21,5
new 11 10 12	10	R1/2	15,7	14	27	22	8	-
11 12 38	12	R3/8	18,7	11,5	27,5	19	10	25,7
11 12 12	12	R1/2	19	14	27,5	22	10	42,1
new 11 12 14	12	R1/4	18,7	11	32	19	8	-

MX 12

Diritto maschio cilindrico

Parallel straight, male

Union simple mâle cylindrique

Gerade Einschraubverschraubung, zylindrisch

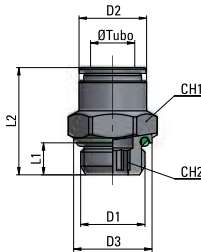

Type	Ø Tubo	D1	D2	D3	L1	L2	CH1	CH2	g ΔΔ
new 12 03 M5	3	M5x0,8	6,5	9	4	16	8	-	-
12 04 M5	4	M5x0,8	9	8	4	19	9	-	4,9
12 04 18	4	G1/8	9	12,9	5	16,5	13	3	8,1
12 06 M5	6	M5x0,8	11,8	8	4	22,5	12	-	10,3
12 06 18	6	G1/8	11,7	12,9	5	19,5	13	4	9,5
12 06 14	6	G1/4	11,7	15,8	6,5	19,5	16	4	15,8
12 08 18	8	G1/8	13,7	12,9	5	23	14	6	12,8
new 12 08 14	8	G1/4	13,7	15,9	6,5	21,5	16	6	15,5
12 08 38	8	G3/8	13,7	20	7	21,5	17	6	-
12 10 14	10	G1/4	15,7	15,8	6,5	27,5	16	8	19,2
new 12 10 38	10	G3/8	16	20	7	25	17	8	24,4
new 12 10 12	10	G1/2	15,8	25	8,5	25,5	22	8	-
12 12 14	12	G1/4	18,8	16	6,5	28,5	19	8	-
12 12 38	12	G3/8	18,8	20	7	28	21	10	31,8
12 12 12	12	G1/2	18,8	25	8,5	26,5	22	10	41,8

MX 13

Diritto femmina

Female straight

Union simple femelle

Gerade Aufschraubverschraubung

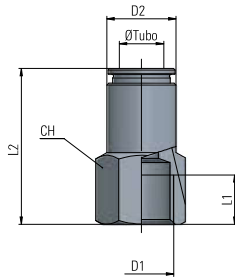

Type	Ø Tubo	D1	D2	L1	L2	CH	g ΔΔ
13 04 18	4	G1/8	9	7	24,5	13	-
13 06 18	6	G1/8	12	7	26,5	13	-
13 06 14	6	G1/4	12	10	31	16	-
13 08 18	8	G1/8	13,8	7	26,5	14	18,2
13 08 14	8	G1/4	14	10	31	16	-
13 08 38	8	G3/8	14	11	32,5	21	-
13 10 14	10	G1/4	15,7	10	33	16	24
13 10 38	10	G3/8	16	11	34,5	21	-
13 10 12	10	G1/2	16	11	36	24	-
13 12 38	12	G3/8	19	11	35,5	21	77,5
13 12 12	12	G1/2	19	11	37	24	-

MX 14

Gomito maschio conico

Taper elbow fitting, male

Raccord à coude mâle conique

Winkerverschraubung, kegelig

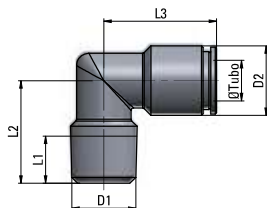

Type	Ø Tubo	D1	D2	L1	L2	L3	g ΔΔ
14 04 18	4	R1/8	9	9,8	17	17,5	10,2
14 06 18	6	R1/8	12	9,8	17	20,5	14
14 06 14	6	R1/4	12	11,3	20,7	20,5	20,8
14 08 18	8	R1/8	14	9,5	18	22,5	19,6
14 08 14	8	R1/4	14	11,3	20,7	22,5	22,3
14 10 14	10	R1/4	16	12,1	21,5	24,5	39,5

MX 15

Gomito maschio conico girevole

Taper swivelling elbow fitting, male

Raccord à coude tournant, mâle conique

Schwenkbare Winkelverschraubung, kegelig

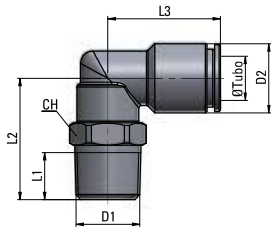

Type	Ø Tubo	D1	D2	L1	L2	L3	CH	g Δ
15 04 18	4	R1/8	9	7,5	18	17,5	10	10,8
15 06 18	6	R1/8	12	7,5	20,5	21,5	13	21,2
15 06 14	6	R1/4	12	11	24,5	21,5	14	25,2
15 08 18	8	R1/8	14	7,5	20,5	22,5	13	22,2
15 08 14	8	R1/4	14	11	24,5	22,5	14	26,3
new 15 08 38	8	R3/8	14	11,5	25	22,5	17	-
new 15 10 14	10	R1/4	16	11	27	26	16	37,5
new 15 10 38	10	R3/8	16	11,5	27,5	26	17	41,1
new 15 10 12	10	R1/2	16	14	32	26	22	-
new 15 12 14	12	R1/4	19	11	30,5	28,5	21	-
new 15 12 38	12	R3/8	19	11,5	31	28,5	21	65,1
new 15 12 12	12	R1/2	19	14	34	28,5	22	71,5

MX 16

Gomito maschio cilindrico girevole

Parallel swivelling elbow fitting, male

Raccord à coude tournant, mâle cylindrique

Schwenkbare Winkelverschraubung, zylindrisch

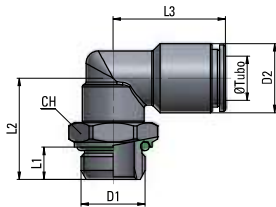

Type	Ø Tubo	D1	D2	L1	L2	L3	CH	g Δ
16 04 M5	4	M5x0,8	9	4	14,5	17,5	9	8,7
16 04 18	4	G1/8	9	5	16,5	17,5	13	12,2
16 06 M5	6	M5x0,8	12	4	15,5	20,5	9	13,2
16 06 18	6	G1/8	12	5	18,5	21,5	13	20,3
16 06 14	6	G1/4	12	6,5	20,5	21,5	16	24,3
16 08 18	8	G1/8	14	5	18,5	22,5	13	21,6
16 08 14	8	G1/4	14	6,5	20,5	22,5	16	25,8
new 16 08 38	8	G3/8	14	7	22,5	22,5	21	-
new 16 10 14	10	G1/4	16	6,5	22,5	26	16	34,6
new 16 10 38	10	G3/8	16	7	24	26	21	41
new 16 10 12	10	G1/2	16	8,5	29	26	22	-
new 16 12 14	12	G1/4	19	6,5	26	28,5	21	-
new 16 12 38	12	G3/8	19	7	26,5	28,5	21	59,5
new 16 12 12	12	G1/2	19	8,5	31	28,5	22	69,2

MX 20

T centrale maschio conico girevole

Swivelling tee fitting, taper

Raccord à té tournant, mâle conique

T-Verschraubung, schwenkbar und kegelig

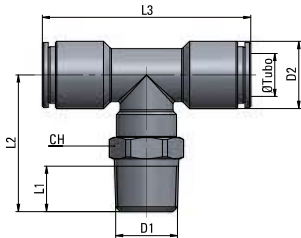

Type	Ø Tubo	D1	D2	L1	L2	L3	CH	g Δ
20 04 18	4	R1/8	9	7,5	21,5	35	10	16,1
20 06 18	6	R1/8	12	7,5	20,5	43	13	30,3
20 06 14	6	R1/4	12	11	24,5	43	14	33,9
20 08 18	8	R1/8	14	7,5	20,5	43	13	32,2
20 08 14	8	R1/4	14	11	24,5	43	14	35,4
20 10 14	10	R1/4	16	11	27,5	51	16	61
20 10 38	10	R3/8	16	11,5	28	51	17	64,1
new 20 12 38	12	R3/8	19	11,5	31	57	21	-
new 20 12 12	12	R1/2	19	14	34	57	22	-

MX 21

T centrale maschio cilindrico girevole

Swivelling tee fitting, parallel

Raccord à té tournant, mâle cylindrique

T-Verschraubung, schwenkbar und zylindrisch

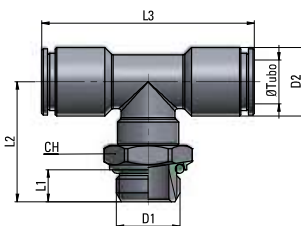

Type	Ø Tubo	D1	D2	L1	L2	L3	CH	g Δ
21 04 M5	4	M5x0,8	9	4	18	35	9	14
21 04 18	4	G1/8	9	5	20	35	13	17,6
21 06 18	6	G1/8	12	5	18,5	43	13	29,2
21 06 14	6	G1/4	12	6,5	20,5	43	16	33,3
21 08 18	8	G1/8	14	5	18,5	43	13	30,7
21 08 14	8	G1/4	14	6,5	20,5	43	16	34,8
21 10 14	10	G1/4	16	6,5	22,5	51	16	57,1
21 10 38	10	G3/8	16	7	24,5	51	21	63,9
new 21 12 38	12	G3/8	19	7	26,5	57	21	-
new 21 12 12	12	G1/2	19	8,5	31	57	22	-

MX 25

Riduzione

Reducer

Réduction

Reduzierstück

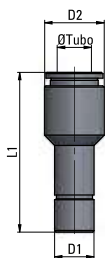

Type	Ø Tubo	D1	D2	L1	g ΔΔ
25 04 06	4	6	9	30,5	6,5
25 06 08	6	8	12	32	11,9
25 06 10	6	10	12	35	-
25 08 10	8	10	14	35	14,8
25 08 12	8	12	14	38	-
25 10 12	10	12	16	41	-

MX 26

Giunzione intermedia

Union

Union simple égale

Gerade Verbindung

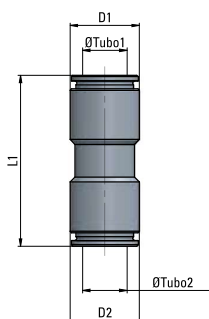

NEW

NEW

Type	Ø Tubo1	Ø Tubo2	D1	D2	L1	g ΔΔ
26 04 04	4	4	9	9	28	7,8
26 06 06	6	6	12	12	33,6	15,7
26 06 04	6	4	12	12	31	15,5
26 08 08	8	8	14	14	34	19,5
26 08 06	8	6	14	14	34	23,8
26 10 10	10	10	16	16	38,6	24,9
26 10 08	10	8	16	14	37,1	-
26 12 12	12	12	19	19	41	40
26 12 10	12	10	19	16	40,3	-

MX 27

Giunzione intermedia passaparete

Bulkhead union

Union traversée de cloison

Gerade Schottverschraubung

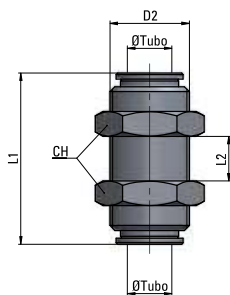

Type	Ø Tubo	D2	L1	L2	CH	g ΔΔ
27 04 04	4	M12x1	28	11,5	16	19,9
27 06 06	6	M14x1	34	15,5	17	31,4
27 08 08	8	M16x1	34	15,5	19	36,8
27 10 10	10	M18x1	39	18,5	21	48,4
27 12 12	12	M20x1	41	20,5	24	61,8

MX 28

Gomito intermedio

Union elbow

Raccord à coude

Winkerverschraubung

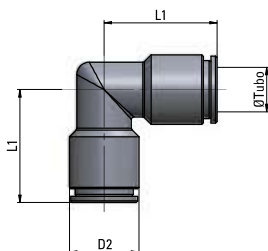

Type	Ø Tubo	D2	L1	g ΔΔ
28 04 04	4	9	17,5	11,7
28 06 06	6	12	21	18
28 08 08	8	14	22,5	24,1
28 10 10	10	16	24,5	43
28 12 12	12	18	27	49,3

MX 29

T intermedio

Union tee

T égal

T-Verschraubung

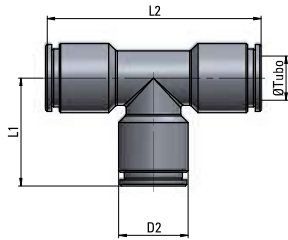

Type	Ø Tubo	D2	L1	L2	g ΔΔ
29 04 04	4	9	17,5	35	14,6
29 06 06	6	12	21	42	29,9
29 08 08	8	14	21,5	43	32,4
29 10 10	10	16	24,5	49	56,1
29 12 12	12	18	27	54	65,9

MX 31

Asta singola

Simple screw

Vis simple

Hohlschraube

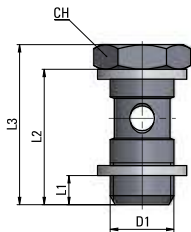

Type	D1	L1	L2	L3	CH	g ΔΔ
31 00 18	G1/8	5,4	24,9	28,9	14	15,1
31 00 14	G1/4	6,4	27,4	32,4	17	26,1
31 00 38	G3/8	6,4	30	36	21	43,6
31 00 12	G1/2	7,5	35,5	41,5	26	76,5

MX 35

Anello singolo

Single banjo ring

Banjo simple

Ringstück

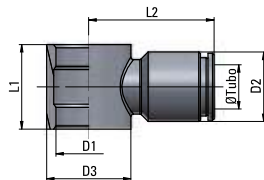

Type	Ø Tubo	D1	D2	D3	L1	L2	g ΔΔ
35 04 18	4	1/8	9	14	15	20,5	13,1
35 06 18	6	1/8	12	14	15	22,5	16,1
35 06 14	6	1/4	12	17	17	24	18,7
35 08 18	8	1/8	14	14	15	23	16,6
35 08 14	8	1/4	14	17	17	25	20,4
35 10 14	10	1/4	16	17	17	27	23,1
35 10 38	10	3/8	16	22	20	29	35,5
35 12 38	12	3/8	16	22	20	31	40,8
35 12 12	12	1/2	19	26	24	33	52,2